

DE LA SALLE COLLEGE

Bonum Certamen Certa – Fight the Good Fight (1Tim 6:12)



YEAR 10

**OPTIONS
HANDBOOK**

2025

IT IS TIME TO START CHOOSING YOUR OPTIONS FOR 2024...

HOW DO I SELECT MY SUBJECTS?

When selecting your subjects for 2024, you need to ask yourself the following questions:

Where does this subject lead to?

This booklet is designed to give you and your family information about subjects that you can choose to study in **the senior school**.

What subjects do I [or would I] enjoy?

Take time to read the subject descriptions on the following pages.

What are my chances of success in these subjects?

Think about your results in assessments so far, talk to your subject teacher.

Do I have the entry requirements for this subject?

Look at the entry requirements on each subject page. Multi-level study is possible. This means that you can study a mixture of courses at different NCEA levels.

What qualifications do I need for tertiary study and/or for the work that I hope to do when I leave school?

Visit the Careers Department. Talk with the Careers Adviser, the Careers Assistants or your Dean and subject teachers. It is especially important to check careers that require you to take particular subjects such as English, Mathematics and Science in the Senior School.

Have I discussed my choices with my parents, careers staff and homeroom and subject teachers?

Please feel free to contact the school directly if your family wish to discuss the option choices process. You should talk to your son's homeroom teacher and/or Dean.

Do not choose subjects

- **because your friends are choosing them.**
- **because you think that they will be easy**
- **without getting advice from family, friends, teachers, and careers guidance**

Remember that these are your subject choices, and they will help direct your future.

HOW MANY COURSES DO I CHOOSE?

In Year 10 **all** students will complete the following Core Subjects

Religious Studies,

English,

Mathematics,

Physical Education and Health,

Science and

Social Studies

Year 10 students select 4 half year options

Students are encouraged to select courses which best suit their needs – it is possible to study at more than one level.

CORE SUBJECTS - RELIGIOUS STUDIES

**YEAR 10
Religious Studies**

**NCEA LEVEL 1
Religious Studies and
Health**

**NCEA LEVEL 2
Religious Studies**

**NCEA LEVEL 3
Religious Studies**

10REL Religious Studies

Contact: Mrs Vaotuaa

Students will be developing knowledge in the areas of Sin and Grace, with a focus on the Sacrament of Reconciliation. They will start preparing for NCEA Level 1 through their exploration of the Middle Ages and the Catholic Church. Students start to develop an understanding of the Meaning and Significance of the Eucharist and why the Church's teachings on Social Justice are so important in establishing a just and Christian

CORE SUBJECTS - ENGLISH

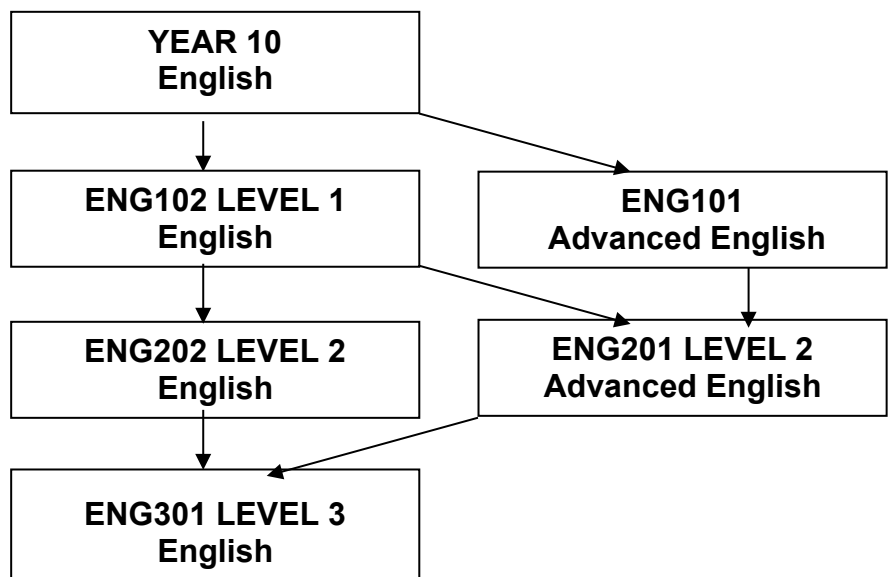

10ENG English

Contact Ms Gani

Year 10 English explores texts around the theme of Courage and Leadership. You will be required to complete work at level 5 of the curriculum. You will be learning how to craft a variety of essays. The aim of this programme is to build vocabulary and to engage students in a wide reading programme. Teachers are to provide multiple opportunities for reading and writing mileage.

CORE SUBJECTS - MATHEMATICS

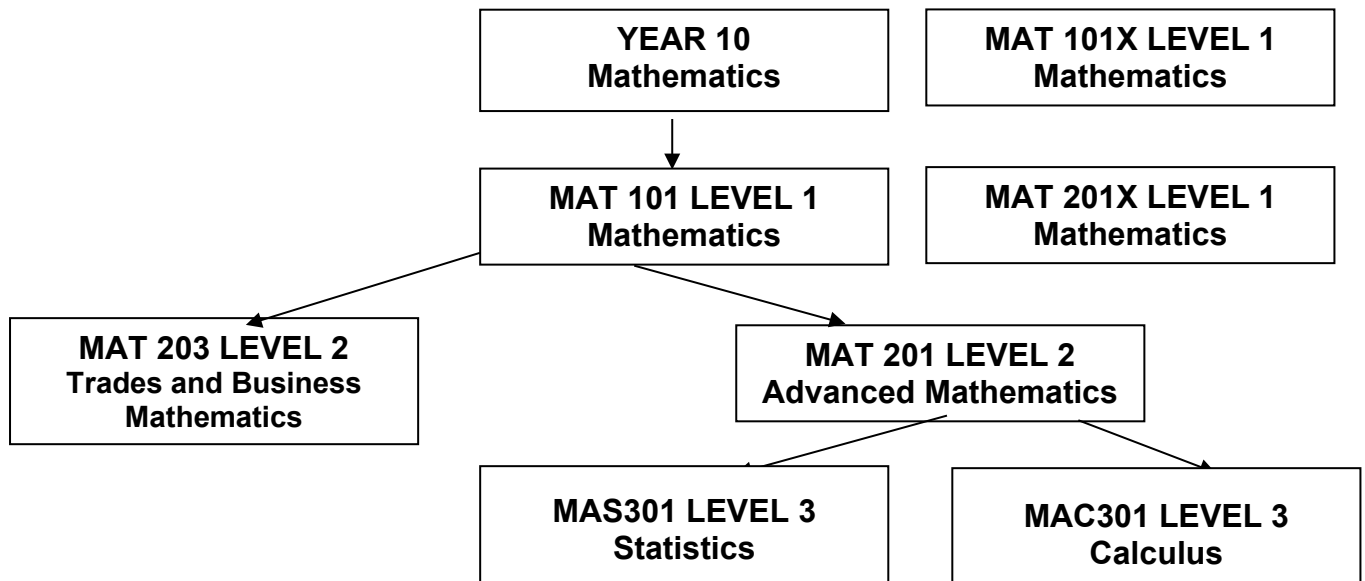

10MAT Mathematics

Contact Mr Vailahi

This course is designed to allow students to cover the 3 Key strands in Mathematics and prepare students towards assessment for NCEA. Students will also sit two NCEA assessments as part of the course.

Some students will have the option of studying NCEA L1 in Year 10 or NCEA L2 in Year 11 in the courses MAT101X AND mat201x. This is invitation only.

CORE SUBJECTS - PHYSICAL EDUCATION and HEALTH

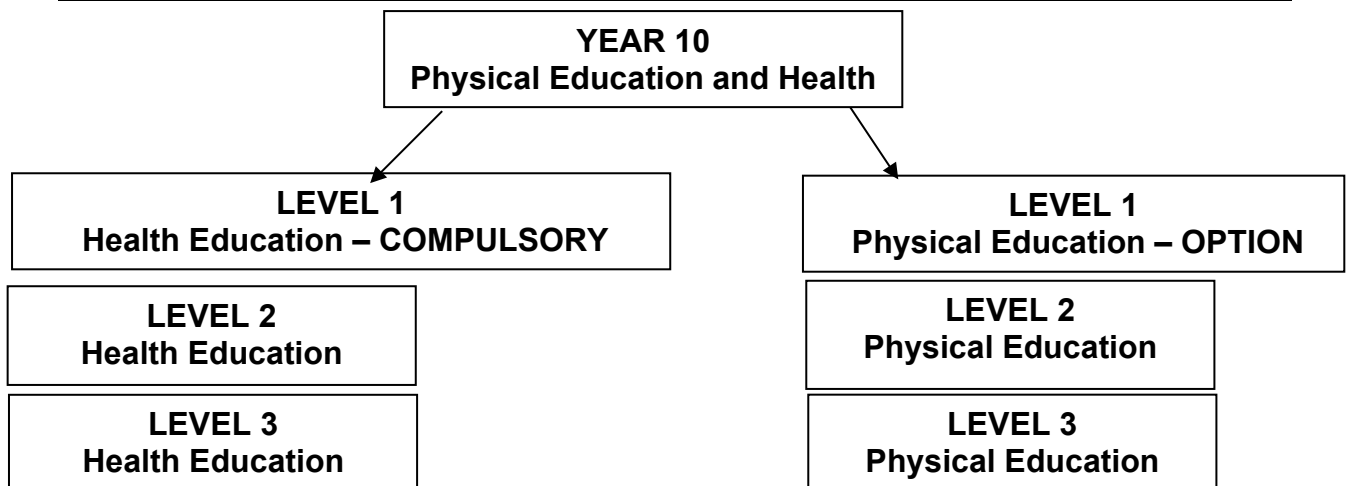

10HPE Physical Education

Contact Mr Keane

Students to participate in a wide variety of Team and Individual sports throughout the year. Invasion Games, Strike and Field Games and Individual Fitness testing are covered in the course. Students are required to participate in all aspects of the course and complete a reflective log on their participation levels. Students cover a wide range of topics in Health Education.

CORE SUBJECTS - SCIENCE

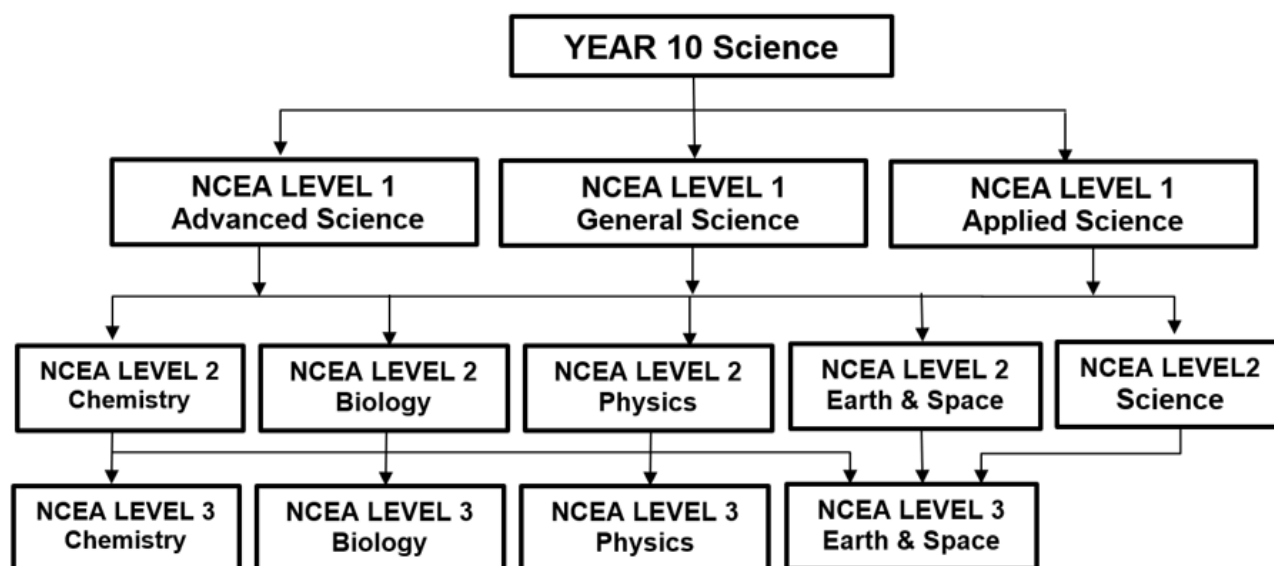

10SCI

Science

Contact: Mr Kumar

This course will hopefully provide inspiration, fun, great engagement and positive reinforcement in learning in the Science cores at Year 10. The content of this course is based on the Physical World, Material World, Living World and Nature of Science strands. It is an academic course with regular sections of practical work at Level 4-5 of the New Zealand Curriculum. The application and use of NZC Key Competencies and Values will be an integral part of delivery of the Year 10 Science Programme at the school.

CORE SUBJECTS - SOCIAL SCIENCES

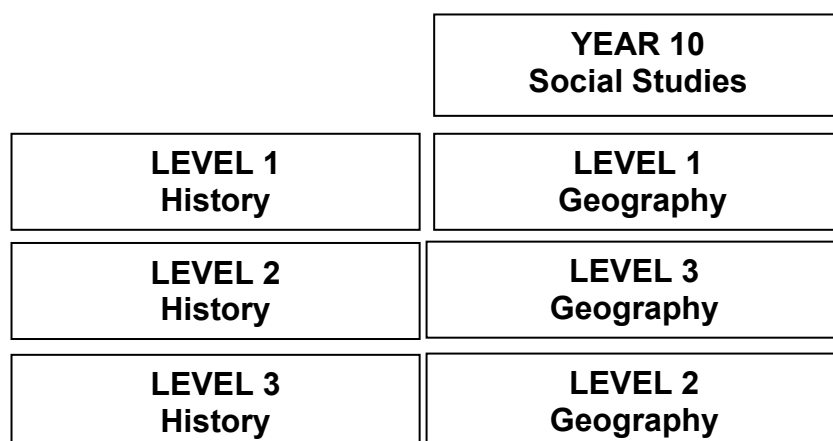

10S0S Social Studies

Contact: Mr Jeremic

Social Studies at Year 10 looks at society and human activity in the contexts of social control, social change, continuity and contemporary issues. Students develop a knowledge and understanding of the diverse and dynamic nature of society and how interactions occur among cultures, societies and environments. Students will develop and apply skills as they investigate society, explore issues, make decisions and work collaboratively. Four topics of study include Current Issue, Economic Decisions about Resources, Human Rights and Post Treaty issues.

OPTION SUBJECTS - ARTS – VISUAL ARTS

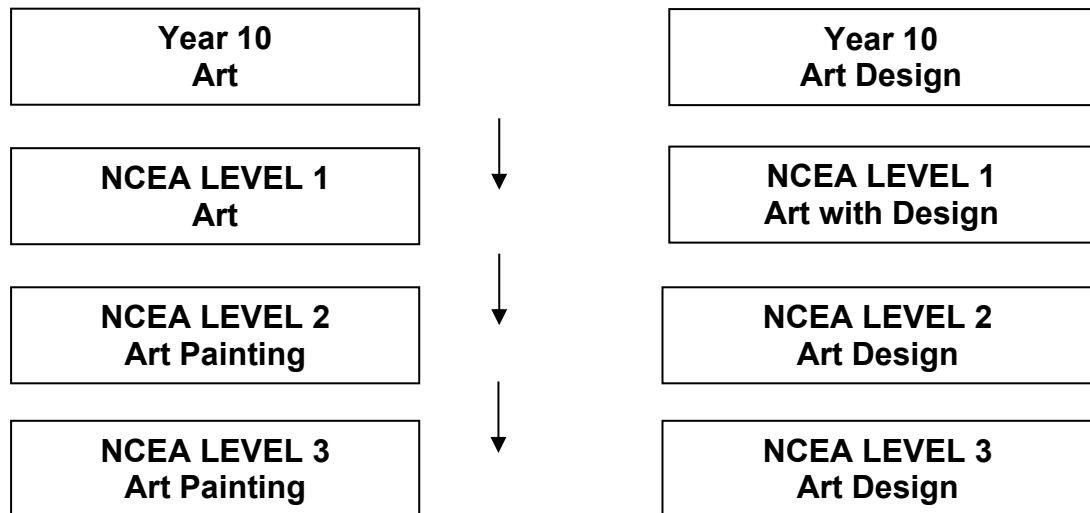

10ARD

Art Design

Contact: Mr Tan

Art Design is an option at Year 10 that runs for two terms. In Art Design, students will build and expand on learning from the strands covered in Year 9 Art and are given the opportunity to experience a range of various digital art making activities. Students learn about a variety of techniques, tools, materials and processes used in Visual Art as well as using subject specific vocabulary and developing critical thinking. The achievement tasks and skills they learn will prepare them for Visual Art at Year 11.

10ART

Art

Contact Mr Tan

Art is an option at Year 10 that runs for two terms. In Art students build and expand on learning from the strands covered in Year 9 and are given the opportunity to experience a range of various practical art making activities. Students learn about a variety of techniques, tools, materials and processes used in Visual Art as well as using subject specific vocabulary and developing critical thinking. They are given the opportunity to study specific artists and create their own artworks in response to the artist works studied as well as their own culture, community and environment. Year 10 Art also covers an Art Design component introducing them to a new way of working which also prepares them for Art Design at Year 12.

OPTION SUBJECTS - ARTS – PERFORMING ARTS

**YEAR 10
Drama**

**NCEA LEVEL 1
Drama**

**NCEA LEVEL 2
Drama**

**NCEA LEVEL 3
Drama**

**YEAR 10
Music**

**NCEA LEVEL 1
Music**

**NCEA LEVEL 2
Music**

**NCEA LEVEL 3
Music**

10MUS Music

Contact: Mr Tan, Mr Williams-Folau

Course description: Students will practice, prepare and rehearse to present substantial performances as both a soloist and a member of a group. Students will research and investigate an aspect of NZ music. Students will also compose two substantial pieces of music.

Performance on a 2nd instrument is offered as an optional standard.

Pre-requisites: Achievement at NCEA Level 1 Music or performance audition and HOD discretion

Course fees: \$30 to cover itinerant music lessons and workbook resources during

10DRA Drama

Contact: Mr Tan, Mr Waugh

Drama is an option at Year 10 that runs for two terms. Students build on techniques and skills learnt from Year 9 and content learnt is important as it is in preparation for NCEA Level 1. There are four units of work – an introductory unit working on creating a group dynamic and developing drama techniques using scripts in pairs, a devising unit exploring the theme of identity and theatre form unit incorporating the features of the form into a performance. Successful participation in this course prepares the student for study at NCEA Level 1 onwards. The core skills taught are confidence, creativity, co-operation, communication and challenge.

CORE SUBJECTS - PHYSICAL EDUCATION and HEALTH

10SPO Sport - Academy [invitation only]

Contact: Mr Keane

Sports Academy is an option at Year 10 that runs for half the year. Membership is by invitation only. Students will be representing the college in a competitive team /s in their chosen sport /s.

OPTION SUBJECTS - LANGUAGES and ESOL

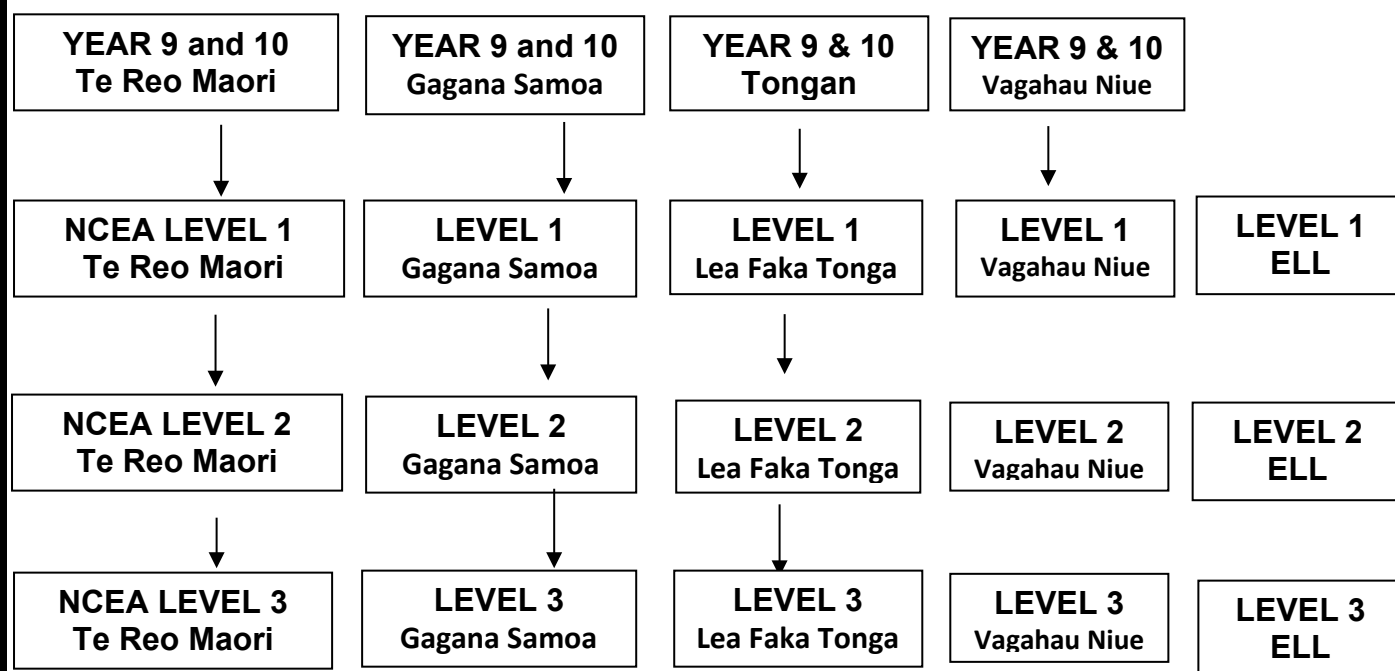

10TRM Te Reo Māori

Contact: Mrs Reti

Te Tupuranga.

Students are developing fluency in listening, speaking, reading and writing in te reo Māori. They will understand and produce information and ideas, using familiar language with some flexibility and pick up some new language from its context. They are becoming more confident in using a range of language learning strategies.

10SAM Gagana Samoa

Contact: Mrs Reti, Mr Endemann

Samoa is an option at Year 10 that runs for two terms. O lau gagana, o lau fa'asinomaga.

Developing fluency in listening, speaking, reading and writing Gagana Sāmoa at the expected level.

Students will understand and produce information and ideas, express and respond to personal needs and interests and use cultural knowledge to communicate appropriately.

10TON Lea Faka Tonga

Contact: Mrs Reti, Mr Ufi

Ko 'ete Tonga' 'a e 'ilo 'etau Lea'

Developing fluency in listening, speaking, reading and writing Lea Faka Tonga is expected at this level.

Students will begin to use language variably and effectively to express and justify their own ideas and opinions, and support or challenge those of others.

10NIU Vagahau Niue

Contact: Mrs Reti, Mr Rex

Developing fluency in listening, speaking, reading and writing Vagahau Niue is expected at this level.

Students will use language variably and effectively to express and justify their own ideas and opinions, and support or challenge those of others.

OPTION SUBJECTS - SOCIAL SCIENCES - COMMERCE

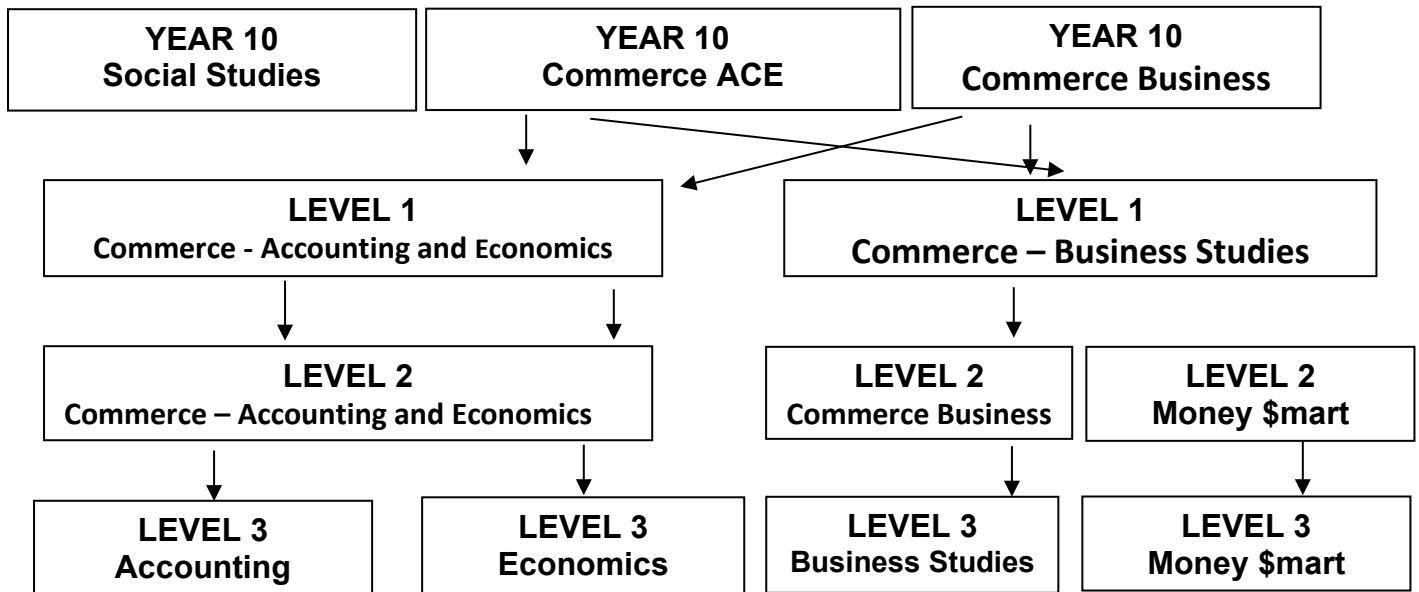

10COA

Contact: Mr Jeremic

The aim of this course is to provide you with an introduction to the basic principles, concepts and skills involved in Accounting and Economics. It will also equip you with important financial literacy skills and help you to decide on commerce options you might wish to take in 2020. All students who take Accounting and Economics can gain the knowledge, skills and attributes required to manage their own finances, become entrepreneurs, run their own business, or contribute effectively to a business or community organisation. You will be given the opportunity to demonstrate your decision-making and evaluation skills. You will also undertake a variety of investigative and statistical work that includes recording and graphing data, data interpreting, tables and graphs. All learning and assessment will include essential numeracy, literacy and communication skills.

10COB Commerce - Business Studies

Contact: Mr Jeremic

Business Studies is an option at Year 10 that runs for two terms. Studying business enables students to appreciate the issues that challenge businesses in a modern world. The aim of this course is to provide you with an introduction to the basic principles, concepts and skills involved in business, marketing and enterprise. This will help you to decide on Commerce options that you might wish to take in 2020. You will be given the opportunity to demonstrate creativity, originality, production and selling skills. The enterprise section is an opportunity for you to demonstrate your enterprise skills, by setting up and operating a business activity. You will also undertake a variety of investigative and statistical work that includes collecting and recording data, graphing data, and interpreting data, tables and graphs. All learning and assessment will include essential numeracy, literacy and communication skills.

OPTION SUBJECTS - TECHNOLOGY

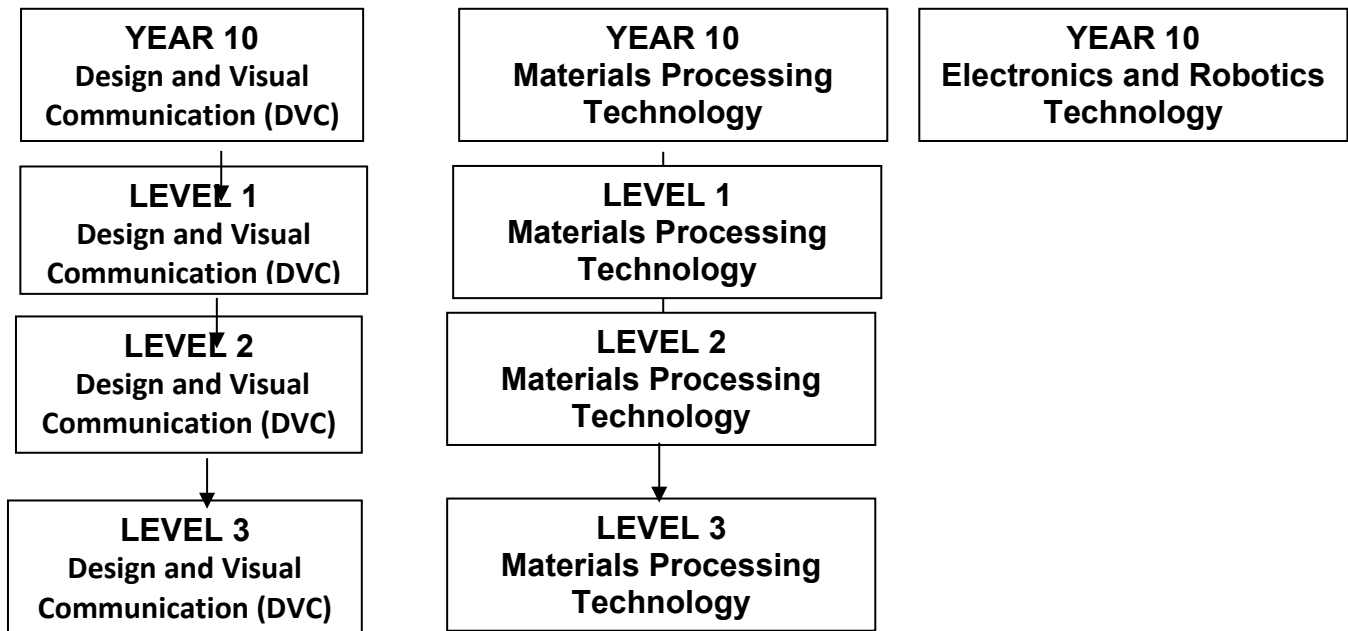

10DVC Design and Visual Communication Contact: Mr Hawkins

This subject is an option at Year 10. Design and Visual Communication (DVC) is a basic introduction study of Spatial Design, Product Design and presenting your designs using any digital platform and or graphic media. Students learn how to visually communicate designs through sketching, drawing critically analysing to present ideas and designs to an audience. To continue DVC in any of the senior years, completing and passing the previous year is a pre-requisite. It will be the building blocks for a possible career in Architecture, Product Design, Landscape Design, Interior Design, Fashion Design, Game Design, any Engineering, Marketing /Advertising. Successful students are good at managing self to meet project deadlines.

10MPT Materials and Processing Technology Contact: Mr Hawkins

Technology is a semester course of two terms. Students may only select one Technology course per semester that is two courses per year. Every course gives you an understanding of what Technology is, the role Technology has in our lives and asks the question - why do we design? Students will be guided through a design process to develop using material or process or digital - electronic outcomes. Students identify when they can use design and visual communication skills, thinking where they should use computational skills that can be aligned within electronic outcomes. The students will research, plan create and evaluate their designs. Their Maori and Pacifica stories support their understanding of learning from the past, designing in the present and ensure there is a sustainable future. They have the opportunity to use the latest digital equipment as as Laser cutter, CNC CAD/CAM and 3 D printing. The courses offered will be Design and Visual Communication, Materials and Processing, Computer Science Technology and, Electronics and Robotics.

OPTION SUBJECTS - DIGITAL TECHNOLOGIES ICT ACADEMY

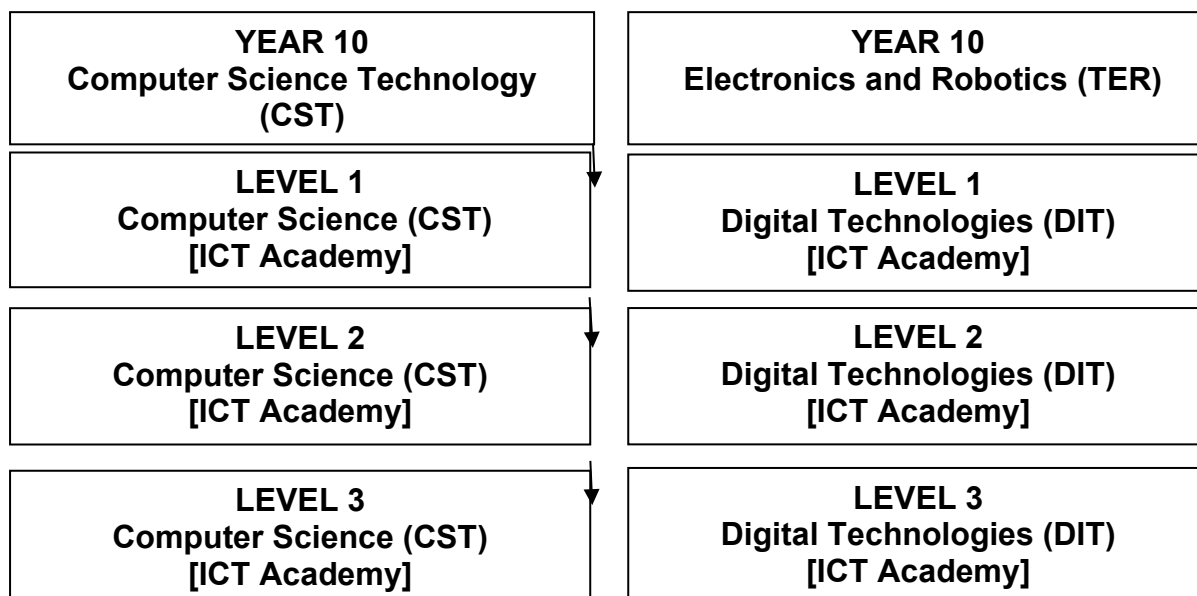

10CST Computer Science

Contact: Mr Hawkins, Mr Singh

Computer Science Technology is an option at Year 10 that runs for two terms. This aim of the course is to prepare and develop educational pathways for students to progress in Computational Thinking, Designing & Developing Digital Outcomes. Students will develop skills and knowledge of tools and techniques in the areas Programming, Spreadsheet, Digital Citizenship & Human Computer Interactions. Students will apply their knowledge and skills as they engage in technological practice to develop their own materials. Extension opportunities will be given to study NCEA Level 1 Achievement Standards in Computer Science. Contact Mr J Singh for more details - singhj@delasalle.school.nz

10TER Electronics and Robotics Technology

Contact Mr Hawkins

Technology is a semester course of two terms. Students may only select one Technology course per semester that is two courses per year. Every course gives you an understanding of what Technology is, the role Technology has in our lives and asks the question - why do we design? Students will be guided through a design process to develop using material or process or digital - electronic outcomes. Students identify when they can use design and visual communication skills, thinking where they should use computational skills that can be aligned within electronic outcomes. The students will research, plan create and evaluate their designs. Their Maori and Pacifica stories support their understanding of learning from the past, designing in the present and ensure there is a sustainable future. They have the opportunity to use the latest digital equipment as as Laser cutter, CNC CAD/CAM and 3 D printing. The courses offered will be Design and Visual Communication, Materials and Processing, Computer Science Technology and, Electronics and Robotics.



De La Salle College

Year 10 Options

2024 – 2025

Name:		Home Room	
--------------	--	------------------	--

Students in Year 10 take 4 half-year options.

Please select 4 options

Faculty	Option		Tick 4 Options
Arts	Art	10ART	
	Art Design	10ARD	
	Drama	10DRA	
	Music	10MUS	
Health and Physical Education	Sports Academy	10SPO	By invitation only
Languages	te reo Māori	10TRM	
	Vagahau Niue	10NIU	
	Gagana Samoa	10SAM	
	Lea Faka Tonga	10TON	
Social Sciences	Commerce ACE	10COA	
	Commerce Business Studies	10COB	
Technology	Materials Processing Technology	10MPT	
	Computer Science Technology	10CST	
	Design and Visual Communication	10DVC	
	Technology – Electronics and Robotics	10TER	

What other options you would like to see at De La Salle College? _____

Discuss your choices with your parents and get them to sign below.
Please return this form to your Homeroom Teacher by **Friday 20 September**.

We have discussed 2025 options with our son

_____ (Parent Signature)

Comments: